

**NEW**

531-70/535-95/533-105/535-125/535-140/540-140/540-170/541-70/550-80 | **CONSTRUCTION LOADALLS**



## **Construction Loadalls**

**531-70/535-95/533-105/535-125/535-140/540-140/540-170/541-70/550-80**

Gross power: 55kW/75hp – 93kW/125hp, Lift capacity: 3100kg – 4999kg, Lift height: 7m – 16.7m



**Why you**  
**should**  
**choose a new**  
**JCB T4i/III B Loadall...**

**NEW** INSTRUMENTS WITH HI-RES TFT SCREEN

**NEW** UP TO 15% MORE TORQUE<sup>†</sup>

**NEW** 7-SPEED VENTILATION FAN

**NEW** JCB ECOMAX T4i/IIIIB ENGINE  
NO DPF REQUIRED



**NEW** IMPROVED, UPWARD AIR EXPULSION

**NEW** UP TO 7% FUEL EFFICIENCY SAVINGS

**NEW** ULTRA EFFICIENT VARI-SPEED COOLING FAN<sup>†</sup>

**NEW** LOW PROFILE ENGINE BONNET

**NEW** EFFICIENT BRAKES FOR 2% FUEL SAVING<sup>†</sup>

**NEW** 55KW ENGINE OPTION<sup>†</sup>

<sup>†</sup> Model dependent

# ULTIMATE PERFORMANCE, ULTIMATE PRODUCTIVITY

THE NEW CONSTRUCTION LOADALL RANGE IS DESIGNED TO MAKE THE MOST EFFICIENT USE OF YOUR TIME AND MONEY. THAT MEANS YOU CAN EXPECT SUPERLATIVE PERFORMANCE, VERSATILITY, VISIBILITY, CYCLE TIMES AND ERGONOMICS. CLASS-LEADING PRODUCTIVITY IS, THEREFORE, A GIVEN.

## A productive machine

**1** A JCB Construction Loadall is extremely manoeuvrable making it easy to operate in confined spaces; the compact wheelbase and large steering lock angles save you valuable travel time on site.

**2** Loadalls come with 4WD as standard (optional 2WD can also be selected to minimise tyre wear and fuel use when roading), helping you maintain plenty of traction and performance in soft, muddy areas. A limited slip differential in the front axle is an option too.

## Productive lifting and hydraulics

**3** JCB's optional Smoothride System (SRS)\* cushions shocks from the boom, improving load retention and increasing operator comfort (and therefore productivity) when travelling at speed on the road or on uneven fields.

\*Model dependant



JCB's new efficient EcoMAX T4i engine produces its power and torque at low engine speeds for great responsiveness, and our wide range of Loadall models means you can find the perfect machine for your requirements.

With a variable geometry turbo for excellent performance at low revs, the JCB EcoMAX T4i engine can provide greater fuel efficiency.\*

**4** The JCB quickhitch system makes attachment-changing quick and easy.

**5** For the most efficient lifting, extending and pushing – our class-leading hydraulics will give you the fastest cycle times.

On our three and four stage boom machines we fit stabilisers for increased stability and lift performance (not 535-95).





### Productive controls

**6** A Construction Loadall has three selectable steer modes. There's two wheel steer, which is ideal for travelling at high speed on the road; four-wheel steer for working in tight spaces; and crab steer for manoeuvring close to walls and buildings.

An optional reversing fan can be used to clear dust and debris from the cooling system to maintain performance.

**7** A selectable transmission dump\* on the foot brake provides superb multi-functioning and increased power during loading or rehandling. Braking itself is smooth and responsive, with all-wheel servo assistance.

**8** For added versatility, all JCB Loadalls are fitted as standard with a single boom auxiliary feature which can power a wide range of attachments.

\*Model dependant



## A SOUND INVESTMENT

A JCB CONSTRUCTION LOADALL ISN'T JUST EFFICIENT TO USE – IT'S HUGEY EFFICIENT TO OWN AND OPERATE TOO. WE'VE DESIGNED THESE MACHINES TO GIVE YOU THE MAXIMUM POSSIBLE RETURN ON YOUR INVESTMENT, WITH GREAT FUEL EFFICIENCY, UNPARALLELED RESALE VALUE AND LOW RUNNING COSTS ALL PART OF THE PACKAGE.

### EcoMAX efficiency

**1** The 81kW and 93kW EcoMAX engines are fitted with a variable speed cooling fan that automatically reacts to ambient temperature, adjusting fan speed for maximum economy and minimum noise.

The new 55kW high-torque engine provides productivity and maximum efficiency.

**2** Because EcoMAX doesn't use exhaust after-treatment, it doesn't need costly heat-resistant lube oils or AdBlue; in turn, you save on servicing costs.

Efficient Design T4i loadalls use up to 7% less fuel than our Tier 3 models.

EcoMAX can be adapted to run on lower-grade fuels, making our Loadalls resalable across different territories, with a corresponding boost to residuals.

We've reduced the Powershift oil level for a 1% energy boost.



By producing high levels of power and torque even at engine speeds as low as 1300-1400rpm, EcoMAX can provide fuel-efficient matching of transmission and hydraulics.



### Further efficiency

3 A JCB Construction Loadall is a great asset in so many respects, not least financially – huge global demand, plus legendary productivity, plus superb build quality equals maximum resale value.

4 High back-off brakes on 531-70, 541-70, 535-95 and 533-105 reduce viscous drag during roading and rehandling, which improves fuel economy by up to 2%.

JCB's Loadall security system is Thatcham-approved (depending on territory), which means you could benefit from lower insurance premiums.



# THE STRONGEST CONTENDER

IN ORDER TO BE TRULY EFFICIENT, OUR CONSTRUCTION LOADALLS ARE DESIGNED TO PROVIDE YOU WITH MAXIMUM UPTIME. TO DO THAT, WE BUILD OUR MACHINES TO BE AS TOUGH AS POSSIBLE, USING TOP QUALITY COMPONENTS AND INNOVATIVE MANUFACTURING PROCESSES. THIS, IN TURN, ENSURES MAXIMUM SERVICE LIFE.

## Tough boom design

- 1 For ultimate strength and durability, we've built in large boom overlaps of more than 1.0m on all of our machines.
- 2 Hoses are routed through the boom for maximum protection.

## Built-in protection

- 3 Bonnets on Construction Loadalls are protected from damage by being side-mounted on the chassis and recessed.
- 4 Our Construction Loadalls have fold-up rear lights that can be kept clear and well protected from on-site damage.
- 5 Opt for front and top screen roof guards for added protection from falling objects.

- 6 Heavy-duty axle feet help a Construction Loadall to absorb the stresses generated during material rehandling applications.

To protect our Construction Loadalls from corrosion over the long term, we dip the cab in electrophoretic alloy before painting it.

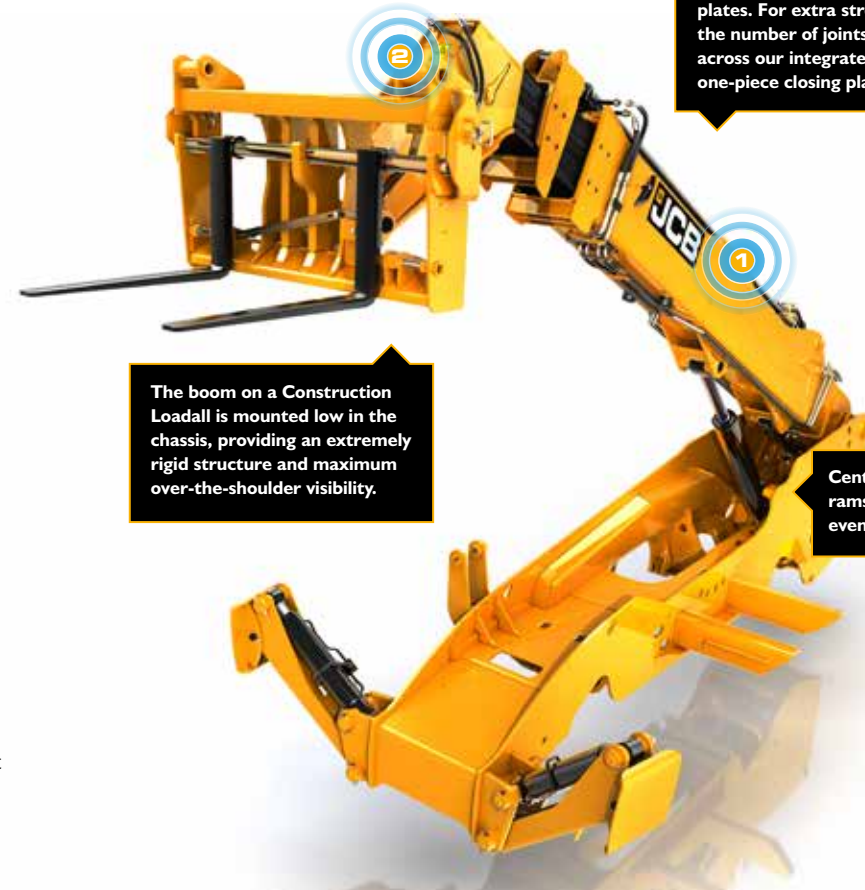

We've fitted a tough inverted U-shaped boom pressing with fully welded closing plates. For extra strength, we've reduced the number of joints and stress points across our integrated boom nose and one-piece closing plate.

The boom on a Construction Loadall is mounted low in the chassis, providing an extremely rigid structure and maximum over-the-shoulder visibility.

Centralised lift and displacement rams ensure load stresses are evenly distributed.



### Durable components

**7** The new Construction Loadall range's stringent testing programme has included prolonged high stress loading of the chassis, boom and other key components, as well as cold climate testing and repeated transmission use over thousands of cycles.

**8** The lift, tilt and extension rams are held in place by keyhole castings for even greater structural integrity.

**9** To prove how good our EcoMAX engines are, we've tested them for 110,000 hours in 70 different machines across the toughest applications and environments.

**10** The one-piece fully welded chassis maximises strength and minimises weight.

**11** At JCB, we make our own hydraulic cylinders, cabs, axles, transmissions and engines – all designed to work in perfect harmony for optimum reliability.



11



7



8



9



10

## A SLICK OPERATION

FOR A MACHINE TO PROVIDE MAXIMUM EFFICIENCY, IT NEEDS TO BE INTUITIVE AND COMFORTABLE TO OPERATE. WITH THAT IN MIND, WE'VE DESIGNED THE NEW CONSTRUCTION LOADALL RANGE TO PROVIDE THE MOST ERGONOMIC OPERATOR ENVIRONMENT POSSIBLE. SO YOU GET THE MOST OUT OF YOUR MACHINE AND YOUR OPERATOR.



### Ergonomic controls

- 1 Simple to use twin manual levers and one manual auxiliary with optional single lever joystick.
- 2 Backlit switches are crystal clear, even in the dark.
- 3 New instruments and a hi-res TFT screen form an intuitive automotive-style layout.
- 4 To create the perfect driving position, opt for the easily adjustable tilting telescopic steering column.



### Comfort and convenience

- 5 The 7-speed fan heater creates the most comfortable, productive operator environment.
- 6 The optional cab, front, rear and boom work lights provide excellent visibility.
- 7 Visibility on a Construction Loadall is excellent, courtesy of direct glazing large roof screen and low profile bonnet.

In addition we have angled our roof bars to ensure maximum visibility when placing at height.

- 8 On our 550-80 and 540-170 Construction Loadalls we have fitted a servo joystick for fast and precise control (optional on a 535-140/535-125).

- 9 The exterior top door slam latch is new – you can now close the upper door from outside and hold the door ajar.



On bright days, a Construction Loadall's standard-fit tinted cab glass will reflect 30% of the sun's energy for enhanced operator comfort.

The new-look Construction Loadall exterior isn't purely cosmetic; the cooling fan airflow is now angled upwards, reducing dust build-up.



# SAFE AND SECURE

A JCB CONSTRUCTION LOADALL CAN SAVE MORE THAN JUST TIME AND MONEY – IT CAN SAVE ITSELF AND ITS OPERATOR FROM POTENTIALLY DANGEROUS SITUATIONS. WE EQUIP OUR LOADALLS WITH STRINGENT SAFETY MEASURES TO PROTECT FROM ACCIDENTS, AS WELL AS EFFECTIVE SECURITY TECHNOLOGY TO GUARD AGAINST THEFT.

Every Construction Loadall has a security system that's Thatcham-approved (depending on territory). This comprises a Cesar Datatag (on UK vehicles), a JCB Livelink telematics vehicle tracker, and an immobiliser.

JCB Adaptive Load Control automatically controls hydraulic operation to help maintain the longitudinal stability of your Construction Loadall.



The operator presence switch on Construction Loadalls disables drive when an operator leaves their seat; this prevents accidental operation.

**1** For quick, easy and safe access, JCB Construction Loadalls have a three-point access and two cab steps.



**2** Hose burst check valves on the rams prevent collapse if a hose fails.

**3** A JCB Construction Loadall has excellent rearward and off-side visibility, courtesy of a low boom and bonnet profile and low boom pivot.

**4** A JCB Loadall comes equipped with a full set of side and rear view mirrors for all round visibility and safety compliance.

**5** For extra safety, a reverse alarm is standard-fit on all Construction Loadalls.

**6** JCB factory-fit immobilisers, can either be activated by a unique key or optional push button PIN system, that automatically arm themselves after a certain period following engine shutdown.



## LESS SERVICING, MORE SERVICE

**NATURALLY, YOU WANT YOUR CONSTRUCTION LOADALL TO SPEND AS MUCH TIME AS POSSIBLE AT WORK, NOT BEING WORKED ON. WHICH IS WHY JCB LOADALLS HAVE LONG SERVICE INTERVALS; AND, WHEN MAINTENANCE DOES NEED TO BE CARRIED OUT, YOU'LL FIND OUR MACHINES ARE EASY AND QUICK TO SERVICE.**

**1** Most Tier 4i engines use a Diesel Particulate Filter (DPF). EcoMAX doesn't. That means no worrying about loss of productivity during the regeneration process and potential extra expense in replacing DPF's. All daily checks, greasing and serviceable components can be accessed at ground level.

**2** You can access a Construction Loadall's battery easily (and without specialist tools) via a lockable cover that's opened with the ignition key.

**3** The diesel tank is also easy to get to, and can be filled from ground level. For protection from dirty fuel, there's an integral pre-filter in the filler neck.

**4** A dry lubricant system means a Loadall's wear pads are extremely durable, with service intervals of 500 hours.

**5** The filters on a Loadall (engine oil, hydraulic oil and fuel) are centrally located for fast, easy servicing.

The air filter is easily accessible, and its double-element design simplifies cleaning. The fact that we design our Construction Loadalls to be fast and easy to service, ensures we have best-in-class SAE serviceability ratings.



For fast, easy inspection of 3 sides of the engine, Construction Loadalls have a large, wide service bay, accessed by a gas-assisted bonnet.



## LIVELINK, WORK SMARTER

**LIVELINK IS AN INNOVATIVE SOFTWARE SYSTEM THAT LETS YOU MANAGE JCB MACHINES REMOTELY – ONLINE, BY EMAIL OR BY MOBILE PHONE. ACCESS EVERYTHING FROM MACHINE ALERTS TO HISTORY INFORMATION, WITH ALL DATA STORED AT A SECURE CENTRE.**

### Productivity and cost benefits

By providing information like idle time monitoring and machine fuel consumption, JCB Livelink helps reduce your fuel usage, saving money and improving productivity. Machine location information can help improve efficiency and perhaps even reduce insurance costs.

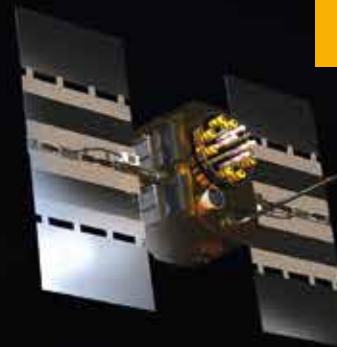

### Maintenance benefits

Manage machine maintenance easily – accurate hours monitoring and service alerts improve maintenance planning, while real-time location data helps you manage your fleet. Critical machine alerts and maintenance history records are also available.



### Security benefits

Livelink's real-time geofencing alerts tell you when machines move out of predetermined zones, and real-time curfew alerts inform you of unauthorised usage. Further benefits include real-time location information, advanced ECU matching (pairs Livelink with the immobiliser or ECU).



## VALUE ADDED

JCB'S WORLDWIDE CUSTOMER SUPPORT IS FIRST CLASS. WHATEVER YOU NEED AND WHEREVER YOU ARE, WE'LL BE AVAILABLE QUICKLY AND EFFICIENTLY TO HELP MAKE SURE YOUR MACHINERY IS PERFORMING TO ITS FULL POTENTIAL.



1

1 Our Technical Support Service provides instant access to factory expertise, day or night, while our Finance and Insurance teams are always on hand to provide fast, flexible, competitive quotes.

2 The global network of JCB Parts Centres is another model of efficiency; with 15 regional bases, we can deliver around 95% of all parts anywhere in the world within 24 hours. Our genuine JCB parts are designed to work in perfect harmony with your machine for optimum performance and productivity.



2

3 JCB Assetcare offers comprehensive extended warranties and service agreements, as well as service-only or repair and maintenance contracts. Irrespective of what you opt for, our maintenance teams around the world charge competitive labour rates, and offer non-obligation quotations as well as fast, efficient insurance repair work.



3

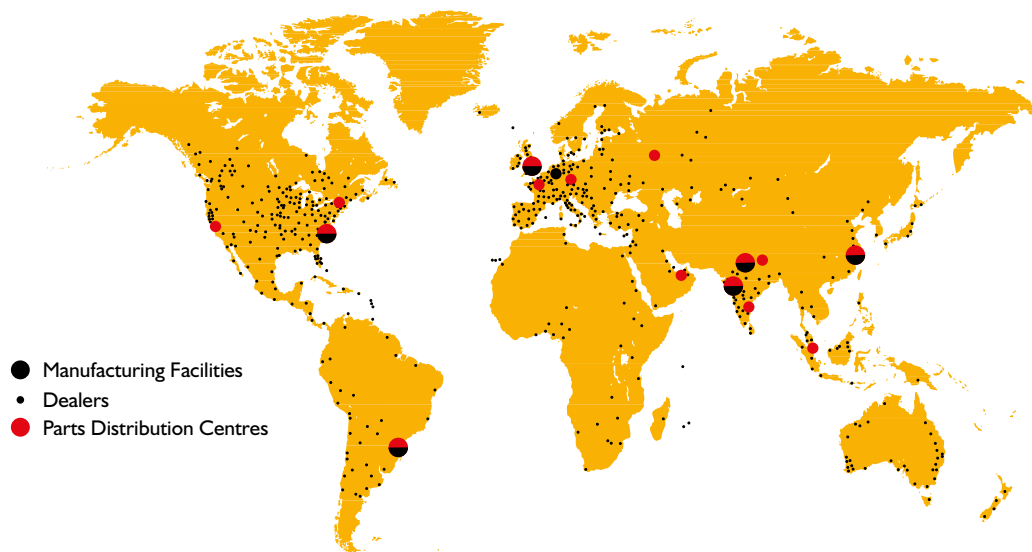

- Manufacturing Facilities
- Dealers
- Parts Distribution Centres

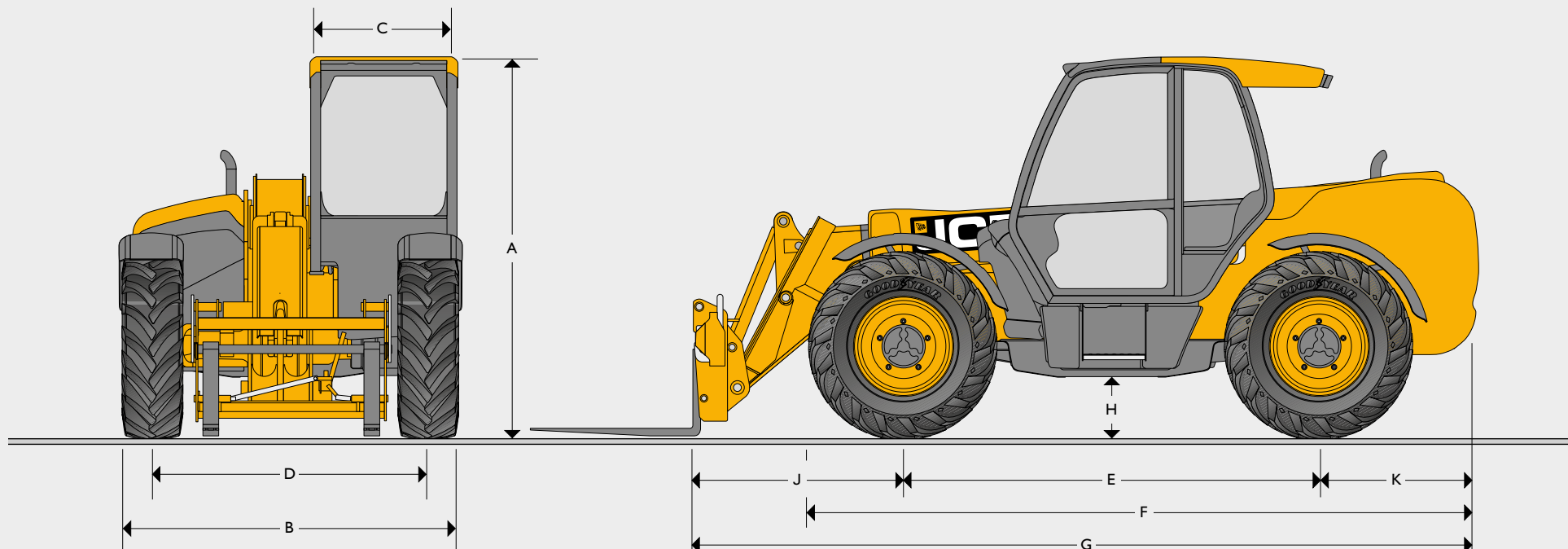

**STATIC DIMENSIONS**

Machine model		531-70	541-70	550-80	535-95	533-105	535-125 HiViz	535-140 HiViz	540-140	540-170
A	Overall height	m	2.49	2.49	2.59	2.49	2.49	2.59	2.59	2.69
B	Overall width (over tyres)*	m	2.23	2.23	2.42	2.36	2.35	2.35	2.35	2.44
C	Inside width of cab	m	0.94	0.94	0.94	0.94	0.94	0.94	0.94	0.94
D	Front track	m	1.81	1.81	1.98	1.87	1.87	1.90	1.90	1.90
E	Wheelbase	m	2.75	2.75	2.75	2.75	2.75	2.75	2.90	2.75
F	Overall length to front tyres	m	4.38	4.38	4.42	4.38	4.38	4.74	4.74	5.08
G	Overall length to front carriage	m	4.99	4.99	5.27	4.99	5.38	5.80	6.23	6.36
H	Ground clearance	m	0.40	0.40	0.40	0.40	0.40	0.40	0.355	0.40
J	Front wheel centre to carriage	m	1.25	1.25	1.46	1.20	1.62	1.68	2.11	1.94
K	Rear wheel centre to rear face	m	0.99	0.99	1.06	1.04	1.01	1.37	1.37	1.67
	Overall width with stabilisers fully deployed	m	NA	NA	NA	2.63	2.57	2.57	2.73	3.55
	Outside turn radius (over tyres)	m	3.7	3.7	3.7	3.7	3.75	3.75	4.10	4.10
	Carriage rollback angle	degrees	42.6	42.6	47.0	41.0	41.2	37.0	37.0	39
	Carriage dump angle	degrees	37.5	37.5	33.0	24.0	24.0	12.5	12.5	9.8
	Weight	kg	7060	7850	101500	8215	8850	9720	10880	11090
	Tyres		15.5/80-24	15.5/80-24	440/80R24	15.5/80-24	15.5/80-24	15.5/80-24	15.5/80-24	15.5/80-24

\* Type Dependent

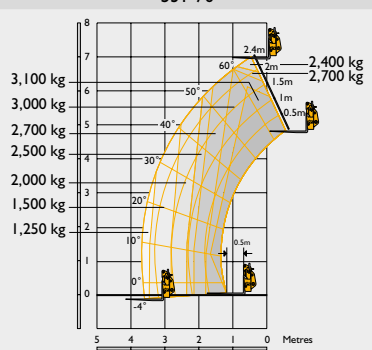
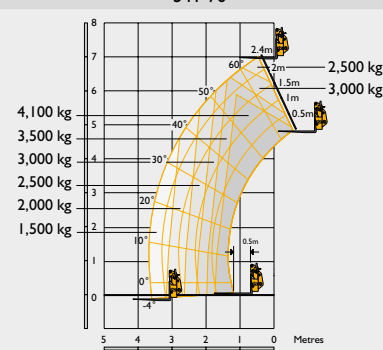
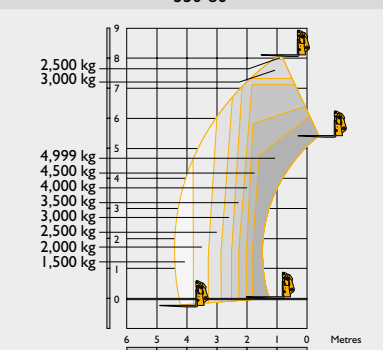
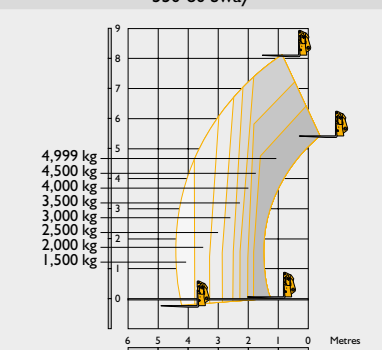

LIFT PERFORMANCE

		531-70	541-70	550-80	550-80 Sway
					
Maximum lift capacity	kg	3170	4100	4999	4999
Lift capacity to full height	kg	2400	2500	2500	4000
Lift capacity at full reach	kg	1250	1500	600	600
Lift height	m	7.0	12.82	16.7	16.7
Reach at maximum lift height	m	0.48	2.94	2.05	2.05
Maximum forward reach	m	3.7	9.25	12.50	12.50
Reach with 1 tonne load	m	3.7	6.25	10.50	10.50
Placing height	m	6.3	12.25	16.20	16.20

Complies with stability test EN 1459 Annex B.

LIFT PERFORMANCE

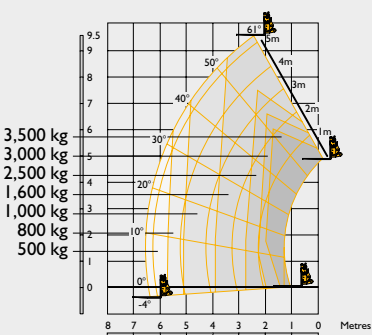
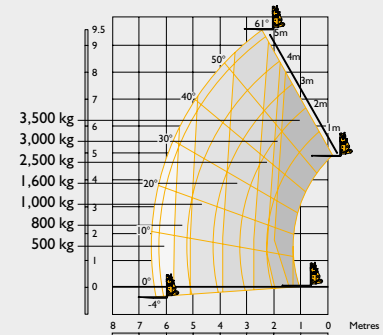
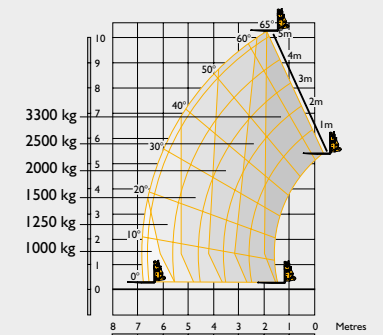
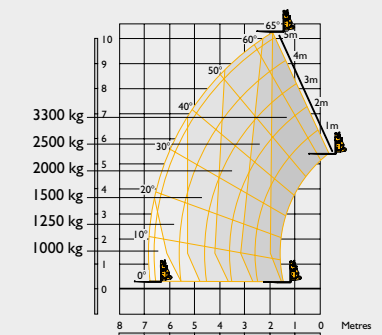
		535-95	535-95 Sway	533-105 Stabilisers retracted	533-105 Stabilisers extended
					
Maximum lift capacity	kg	3500	3500	3300	3300
Lift capacity to full height	kg	1600	1600	1000	3300
Lift capacity at full reach	kg	500	500	375	1000
Lift height	m	9.50	9.50	9.85	10.22
Reach at maximum lift height	m	2.43	2.43	2.63	1.91
Maximum forward reach	m	6.52	6.52	6.91	6.83
Reach with 1 tonne load	m	5.08	5.08	4.83	6.83
Placing height	m	8.78	8.78	9.44	9.82

Complies with stability test EN 1459 Annex B.

LIFT PERFORMANCE

	535-125 HiViz Stabilisers retracted	535-125 HiViz Stabilisers extended	535-140 HiViz Stabilisers retracted	535-140 HiViz Stabilisers extended
Maximum lift capacity	kg 3500	kg 3500	kg 3500	kg 3000
Lift capacity to full height	kg 1500	kg 3500	kg 1500	kg 1250
Lift capacity at full reach	kg 200	kg 1150	kg 200	kg 13.47
Lift height	m 12.28	m 12.07	m 13.78	m 0.93
Reach at maximum lift height	m 1.36	m 0.46	m 1.94	m 9.60
Maximum forward reach	m 8.10	m 8.06	m 9.70	m 9.60
Reach with 1 tonne load	m 5.31	m 8.06	m 6.61	m 13.30
Placing height	m 11.43	m 11.75	m 13.02	m 13.02

Complies with stability test EN 1459 Annex B. Chassis Levelling (Sway) with stabilisers retracted (Sway angle ±9°).

LIFT PERFORMANCE

	540-140 Stabilisers retracted	540-140 Stabilisers extended	540-170 Stabilisers retracted	540-170 Stabilisers extended
Maximum lift capacity	kg 4000	kg 4000	kg 4000	kg 4000
Lift capacity to full height	kg 2000	kg 4000	kg 1500	kg 2500
Lift capacity at full reach	kg 200	kg 1250	kg 0	kg 600
Lift height	m 12.82	m 13.8	m 11.57	m 16.7
Reach at maximum lift height	m 2.94	m 0.74	m 4.15	m 2.05
Maximum forward reach	m 9.25	m 9.25	m 9.04	m 12.50
Reach with 1 tonne load	m 6.25	m 9.25	m 5.76	m 10.50
Placing height	m 12.25	m 13.25	m 10.90	m 16.20

Complies with stability test EN 1459 Annex B.

**ENGINE**

JCB EcoMAX T4i/IIIB, Capacity 4 cylinder 4.4ltrs, Aspiration turbocharged cooled

	531-70	541-70	550-80	535-95	533-105	535-125 HiViz	535-140 HiViz	540-140	540-170
Engine 55kW (75hp) @ 2200rpm, 400Nm torque at 1300rpm	Standard	Standard	N/A	Standard	Standard	Standard	Standard	Standard	N/A
Engine 81kW (109hp) @ 2200rpm, 512Nm torque at 1300rpm	Option	Option	N/A	Option	Option	Option	Option	Option	Standard
Engine 93kW (125hp) @ 2200rpm, 550Nm torque at 1300rpm	Option	Option	Standard	Option	Option	Option	Option	Option	Option

**HYDRAULIC CYCLE TIMES**

	531-70	541-70	550-80	535-95	533-105	535-125 HiViz	535-140 HiViz	540-140	540-170
Boom raise	s 7.2	8.8	7.4	9.1	8.8	10.4	13.5	15.1	22.7
Boom lower	s 5.4	6.5	5.9	7.7	8.5	8.1	11	15.5	23.4
Extend	s 6.8	6.8	8.3	10.5	13.2	15.7	15.6	19.5	18.3
Retract	s 5	5	5.9	11.2	13.6	12.8	14.4	19.2	16.7
Bucket dump	s 3.5	3.5	2.8	2.4	2.4	1.8	1.7	3.2	4.2
Bucket crowd	s 2.9	2.9	3.0	3.5	3.4	2.3	2.0	2.5	4.6

**HYDRAULICS**

	Hydraulic System Pressure (bar)	Max. Pump flow (litres)
531-70	241	82
541-70	260	82
550-80	260	140
535-95	241	82
533-105	241	82
535-125	260	260
535-140	110	110
540-140	241	103
540-170	260	90+72

**TRANSMISSION**

Torque converter, 4 speed powershift gearbox (550-80 3 speed powershift gearbox).

**Travel speed 531-70/541-70/535-95/533-105:** 29kph, 33kph (when 2/4WD select is specified).**Travel speed 535-125/535-140 540-140/540-170:** 29kph. Optional 33kph transmission.**Travel speed 550-80:** 20kph (dependent upon territory and tyre selection): Permanent 4 wheel drive.**BRAKING****Service brake:** Servo-assisted, hydraulically oil-immersed multi-disc on front and rear axle. (550-80 Hydraulically activated power brakes)**Parking brake:** Hand operated disc brake on output of gearbox. (93kW/125hp – oil immersed disc type).**CAB**

Conforms to ROPS ISO 3471 and FOPS ISO 3449

**OPTIONS**

Front and rear working lights, rotating flashing beacon, fire extinguisher, traction and industrial tyres, electrical 2/4WD select, limited slip differential in front axle, windscreen and roof guard, air suspension seat, deluxe cab trim, roof and front screen blind, radio kit, air conditioning, reversing fan, deluxe trim, armrest (SLC only), roof moulding.

Single lever mechanical joystick, with push button extend and retract.



#### Construction Loadalls

531-70/535-95/533-105/535-125/535-140/

540-140/540-170/541-70/550-80

Gross power: 55kW/75hp – 93kW/125hp

Lift capacity: 3100kg – 4999kg

Lift height: 7m – 16.7m

Your nearest JCB dealer